

POWER RELAY

1 POLE - 1/3/5/10A Medium Load Control

LZ Series

■ FEATURES

- UL, CSA, SEV recognized
 - Contact rating types - Low level to 10 amps switching
 - Standard and high sensitivity types available
 - High surge strength version available
 - UL class B (130°C) insulation type available (only plastic sealed type)
 - Printed circuit terminals - 0.1" grid pitch
 - Plastic sealed type, RTIII
 - RoHS compliant.
- Please see page 9 for more information



■ PARTNUMBER INFORMATION

[Example] $\frac{LZ}{(a)}$ - $\frac{B}{(b)}$ $\frac{12}{(c)}$ $\frac{H}{(d)}$ $\frac{M}{(e)}$ $\frac{S}{(f)}$ $\frac{E}{(g)}$ - $\frac{K}{(h)}$ $\frac{HV}{(i)}$ - $\frac{UC}{(j)}$

(a)	Relay type	LZ	: LZ-Series
(b)	Coil wire class	Nil B	: Standard type : UL class B insulation type (130 °C)
(c)	Coil rated voltage	12	: 1.5.....100 VDC Coil rating table at page 3
(d)	Contact type	Nil H V W	: 3A : 5A : 10A (standard coil power only) : 1A (bifurcated contact)
(e)	Contact configuration	Nil M	: 1 form C (SPDT) : 1 form A (SPST-NO)
(f)	Coil type	Nil S	: Standard type (450-600mW) : High sensitive type (300mW)
(g)	Contact material	Nil Nil Nil E	: Gold overlay silver-palladium (1A) (only LZ-W) : Gold overlay silver-nickel (3A, 5A) : Silver alloy (10A) (only LZ-V) (contains cadmium) : Silver-nickel (3A, 5A)
(h)	Enclosure	Nil K C	: Flux proof type, RTII : Plastic sealed type (recommended for new designs) RTIII : Plastic sealed type (with tape) RTIII
(i)	Surge strength	Nil HV	: Standard type (4,000V) : High surge strength type (6,000V)
(j)	Approvals	UC	: UL, CSA approved type

LZ SERIES

■ SPECIFICATION

LZ- () (Standard type)

Item			10A Type	5A Type	3A Type	1A Type	
			LZ- () V LZ- () VM	LZ- () H LZ- () HE	LZ- () LZ- () E	LZ- () W	
Contact Data	Configuration		1 form A (SPST-NO), 1 form C (SPDT)				
	Construction		Single	Single (crossbar)		Bifurcated (crossbar)	
	Material		Silver alloy (contains cadmium)	Gold overlay silver alloy Silver alloy (LZ-HE, E)		Gold overlay silver-palladium	
	Resistance (initial) (at 6 VDC, 1A)		Max. 100 mΩ	Max. 70 mΩ (LZ-H, LZ) Max. 100 mΩ (LZ-HE, E)		Max. 50 mΩ	
	Contact rating (resistive)		10A, 120VAC/24VDC 1/4hp, 120VAC	5A, 120VAC/ 24VDC 1/8hp, 120VAC	3A, 120VAC/ 30VDC 1/10hp, 120VAC	1A, 120VAC / 30VDC	
	Max. carrying current		10A	5A		1A	
	Max. switching voltage		250VAC, 150 VDC				
	Max. switching power		1,680VA, 240W	960VA, 120W	600VA, 90W	190VA, 30W	
	Max. switching current		10A	5A	3A	1A	
	Min. switching load *		100mA 5VDC	10mA, 5VDC (LZ-H) 100mA, 5VDC (LZ-HE)	10mA, 5VDC(LZ-) 100mA, 5VDC (LZ-E)	0.1mA, 100mVDC	
Life	Mechanical		Min. 20 x 10 ⁶ operations				
	Electrical		Min. 100 x 10 ³ operations (contact rating)				
Coil Data	Rated Power (at 20 °C)		450 - 600mW				
	Operate Power (at 20 °C)		170 - 220 mW (LZ- () V : 290 - 390 mW)				
	Operating temperature range		-30 °C to +70 °C (no frost)				
Timing Data	Operate (at nominal voltage)		Max. 7 ms (without bounce)				
	Release (at nominal voltage)		Max. 4 ms (no diode)				
Insulation	Resistance (initial)		Min. 250MΩ at 500VDC				
	Dielectric strength	Open contacts	750VAC, 1min				
		Contacts to coil	2,000VAC, 1min				
	Surge strength	Coil to contacts	4,000V / High surge: 6,000V, 1.2 x 50μs standard wave				
Other	Vibration resistance	Misoperation	10 to 55Hz double amplitude 3.3 mm				
		Endurance	10 to 55Hz double amplitude 3.3 mm				
	Shock	Misoperation	Min. 100m/s ² (11 ± 1ms)				
		Endurance	Min. 1,000m/s ² (6 ± 1ms)				
	Weight	Approximately 7.7g					

* Minimum switching loads mentioned above are reference values. Please perform the confirmation test with actual load before production since reference values may vary according to switching frequencies, environmental conditions and expected reliability levels.

■ SPECIFICATION

LZ-() S (High sensitive type)

Item			5A Type	3A Type	1A Type
			LZ-()HS, LZ-()HSE	LZ-()S, LZ-()SE	LZ-()WS
Contact Data	Configuration		1 form A (SPST-NO), 1 form C (SPDT)		
	Construction		Single (crossbar)		Bifurcated (crossbar)
	Material		Gold overlay silver nickel	Silver nickel (LZ-HSE, SE)	Gold overlay silver-palladium
	Resistance (initial) (at 6VDC, 1A)		Max. 70mΩ (LZ-HS, S) Max. 100mΩ (LZ-HSE, SE)		Max. 50mΩ
	Contact rating	Resistive	5A, 120VAC / 24VDC	3A, 120VAC / 30VDC	1A, 120VAC / 30VDC
		Motor load	1/8 hp, 120VAC	1/10 hp, 120VAC	-
	Max. carrying current		5A		1A
	Max. switching voltage		250VAC, 150 VDC		
	Max. switching power		960VA, 120W	600VA, 90W	190VA, 30W
	Max. switching current		5A	3A	1A
Min. switching load *		10 mA, 5VDC (LZ-HS, S) 100 mA, 5VDC (LZ-HSE, SE)		0.1 mA, 100mVDC	
Life	Mechanical		Min. 20 x 10 ⁶ operations		
	Electrical		Min. 100 x 10 ³ operations		
Coil Data	Rated power (at 20 °C)		330 mW		
	Operate power (at 20 °C)		140 mW		
	Operating temperature range		-30 °C to +80 °C (no frost)		
Timing Data	Operate (at nominal voltage)		Max. 7 ms		
	Release (at nominal voltage)		Max. 4 ms		
Insulation	Resistance (initial)		Min. 250MΩ at 500VDC		
	Dielectric strength	Open contacts	750VAC, 1min		
		Contacts to coil	2,000VAC, 1min		
	Surge strength	Coil to contacts	4,000V / -HV type: 6,000V, 1.2 x 50μs standard wave		
Other	Vibration resistance	Misoperation	10 to 55Hz double amplitude 3.3 mm		
		Endurance	10 to 55Hz double amplitude 3.3 mm		
	Shock	Misoperation	Min. 100m/s ² (11 ± 1ms)		
		Endurance	Min. 1,000m/s ² (6 ± 1ms)		
	Weight	Approximately 7.7 g			

* Minimum switching loads mentioned above are reference values. Please perform the confirmation test with actual load before production since reference values may vary according to switching frequencies, environmental conditions and expected reliability levels.

■ COIL RATING

Standard type (450 mW)

Coil Code	Rated Coil Voltage (VDC)	Coil Resistance +/- 10% (Ohm)	Must Operate Voltage (VDC) *		Must Release Voltage (VDC) *	Rated Power (mW)
			LZ-(B) () VM LZ-(B) () (M) (E) LZ-(B) () W (M)	LZ-(B) () V		
1.5	1.5	5	0.97	1.2	0.08	450
3	3	20	1.95	2.4	0.15	
5	5	56	3.25	4	0.25	
6	6	80	3.9	4.8	0.3	
9	9	180	5.85	7.2	0.45	
12	12	320	7.8	9.6	0.6	
18	18	720	11.7	14.4	0.9	
24	24	1,280	15.6	19.2	1.2	
48	48	3,800	28.8	38.4	2.4	600
100	100	22,200	65	80	5	450

High sensitive type (330 mW)

Coil Code	Rated Coil Voltage (VDC)	Coil Resistance +/- 10% (Ohm)	Must Operate Voltage (VDC) * ¹	Must Release Voltage (VDC) * ¹	Rated Power (mW)
1.5	1.5	6.8	0.97	0.08	330
3	3	27	1.95	0.15	
5	5	80	3.25	0.25	
6	6	110	3.9	0.3	
9	9	250	5.85	0.45	
12	12	440	7.8	0.6	
18	18	990	11.7	0.9	
24	24	1,780	15.6	1.2	

Note: All values in the table are valid for 20°C and zero contact current.

* Specified operate values are valid for pulse wave voltage.

■ SAFETY STANDARDS

Type	Compliance	Contact rating
UL	UL 508	Flammability: UL 94-V0 (plastics)
	E 56140, E 45026	[LZ-()W, LZ-()WS] 0.8A, 240VAC (resistive)
CSA	C22.2 No. 14 LR 35579	1A, 120VAC / 30VDC (resistive)
		[LZ-(), LZ-()S] 2.5A, 240 VAC (resistive)
		3A, 120 VAC / 30VDC (resistive)
		1/10hp, 120VAC/240VAC
		Pilot duty: D150
		[LZ-()H, LZ-()HS] 4A, 240 VAC (resistive)
		5A, 30 VAC resistive)
		1/10 HP, 120VAC/2400VAC
		Pilot duty: D150
		[LZ-()V] 7A, 240 VAC (resistive)
10A, 120 VAC / 30VDC (resistive)		
1/4hp, 120VAC/240VAC		

Also complies with SEV.

CHARACTERISTIC DATA

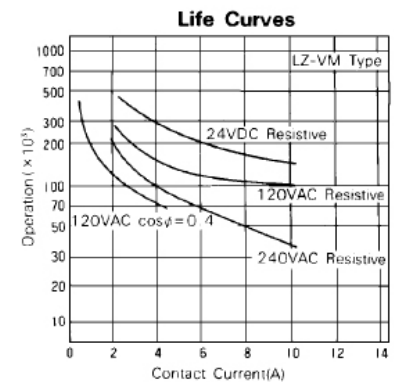
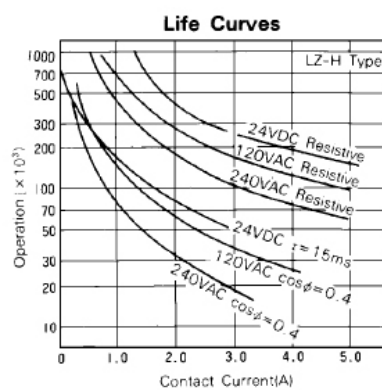
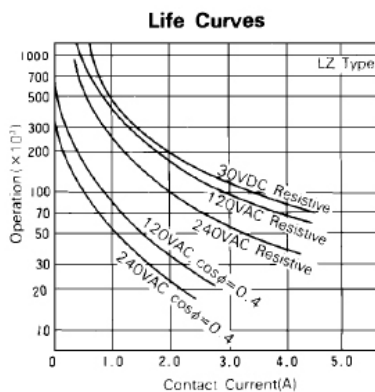
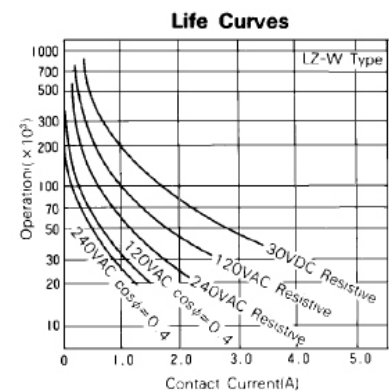
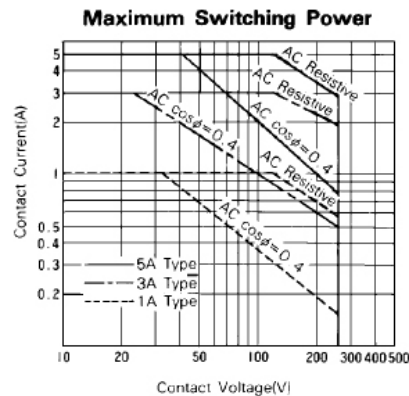
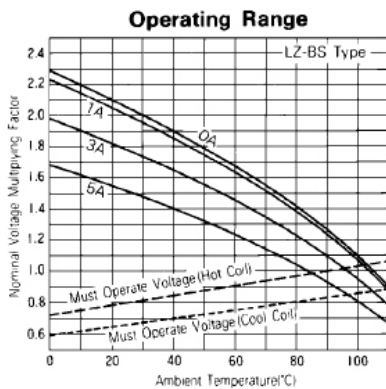
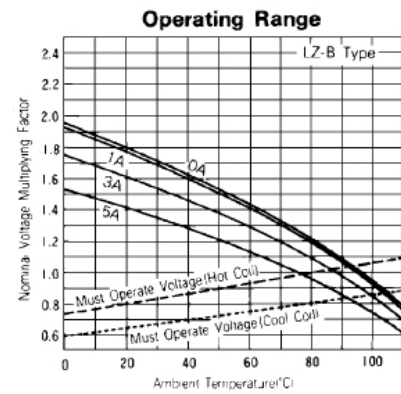
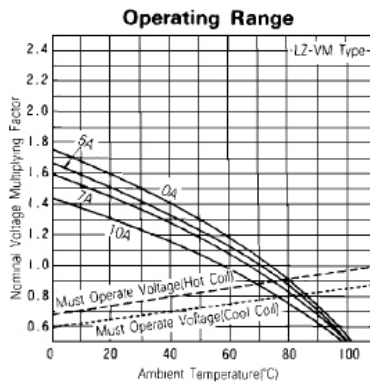
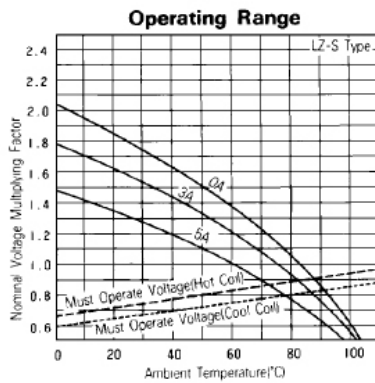
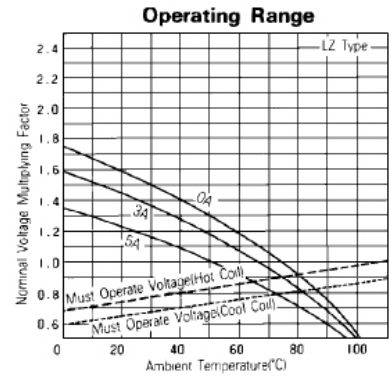
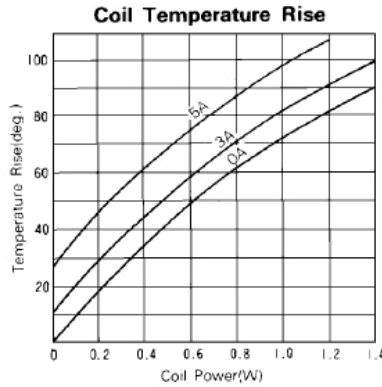
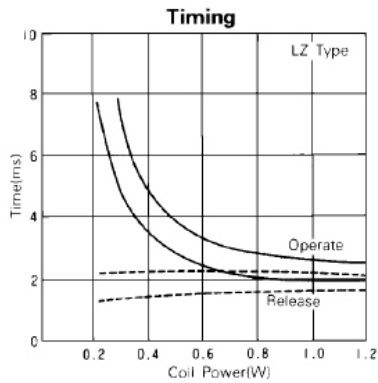

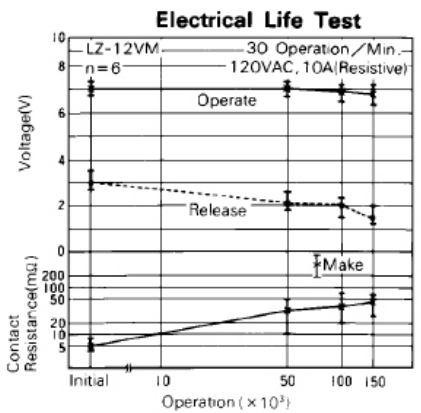
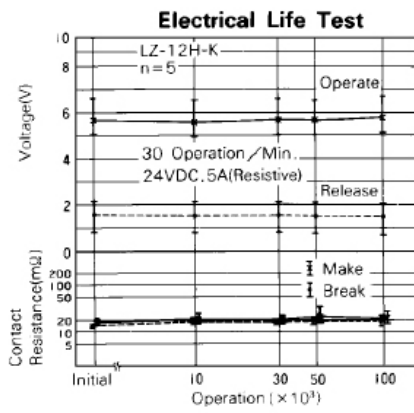
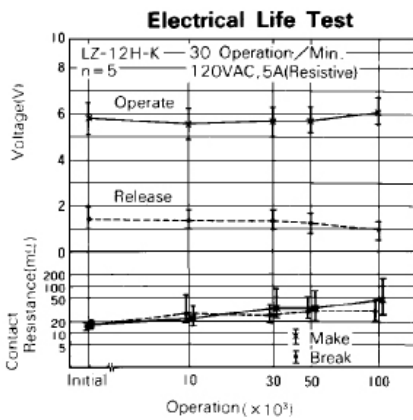
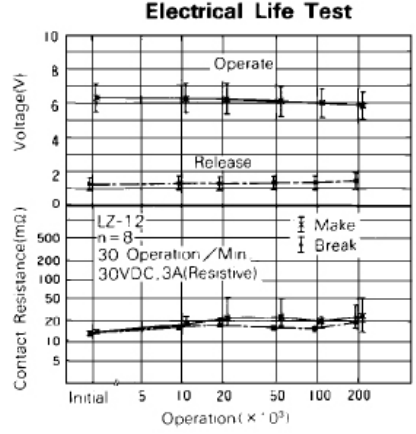
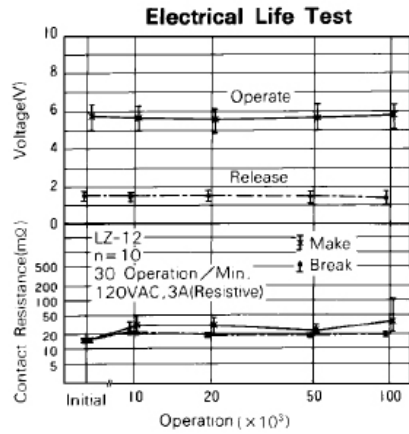
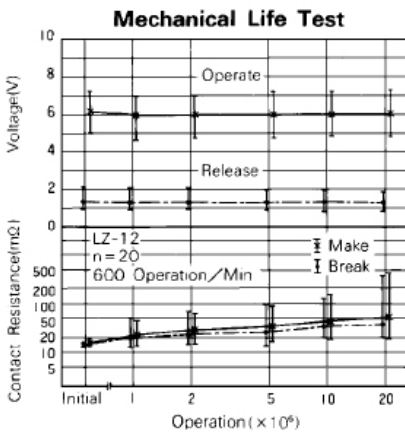
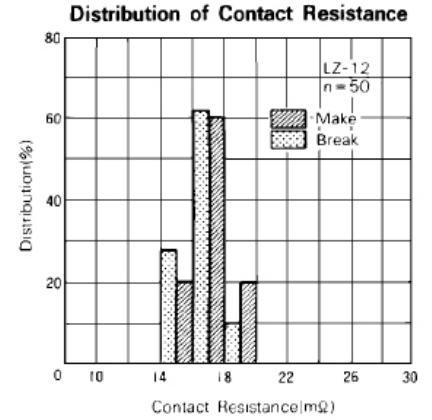
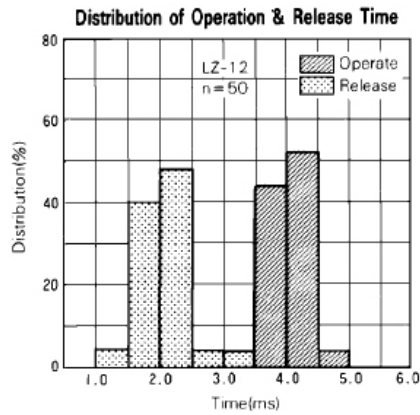
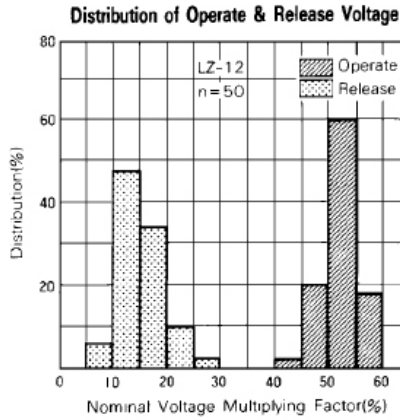

■ DIMENSIONS

● Dimensions

LZ-M type (Flux proof type)

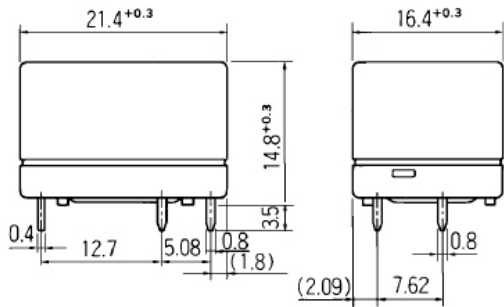

● Schematics

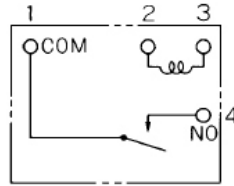

● PC board mounting hole layout (BOTTOM VIEW)

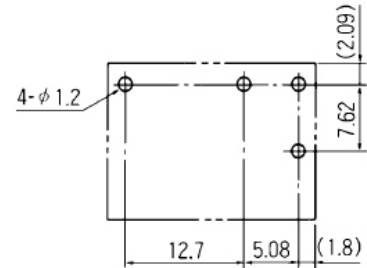

LZ-M-K, LZ-M-C type (Plastic sealed type or sealed with tape)

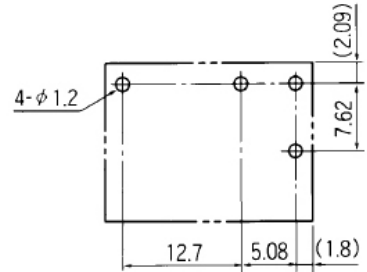
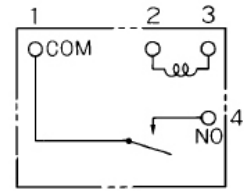
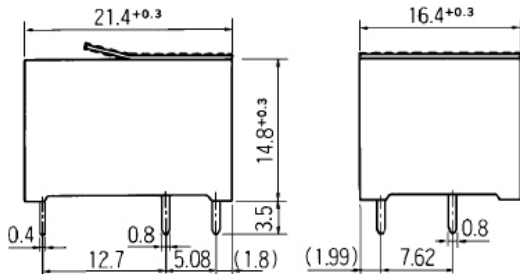

Dotted line: Seal tape (LZ-M-C type)

LZ type (Flux proof type)

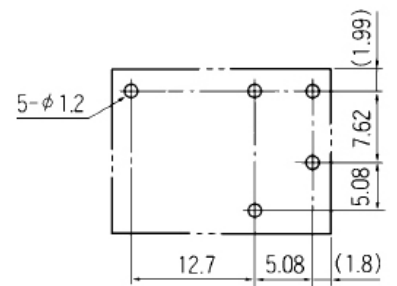
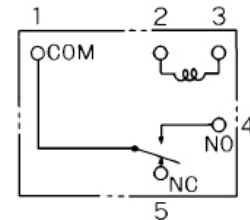
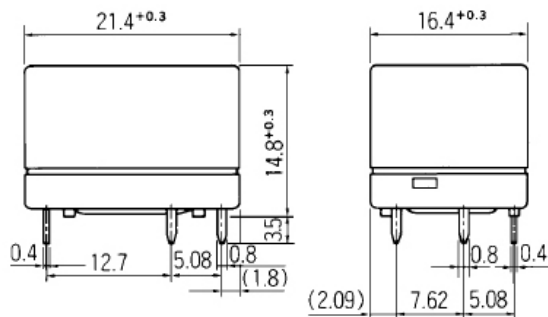

LZ-K, LZ-C type (Plastic sealed type or sealed with tape)

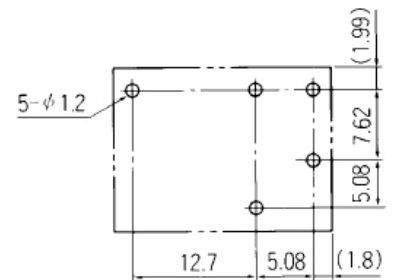
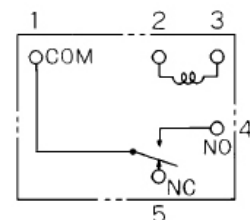
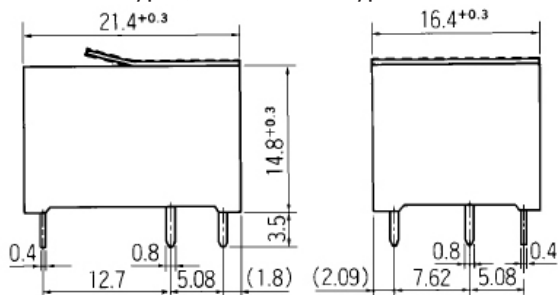

Dotted line: Seal tape (LZ-C type)

RoHS Compliance and Lead Free Information

1. General Information

- All relays produced by Fujitsu Components are compliant with RoHS directive 2011/65/EU including amendments.
- Cadmium as used in electrical contacts is exempted from the RoHS directives. As per Annex III of directive 2011/65/EU.
- All relays are lead-free. Please refer to Lead-Free Status Info for older date codes at: <http://www.fujitsu.com/downloads/MICRO/fcai/relays/lead-free-letter.pdf>
- Lead free solder plating on relay terminals is Sn-3.0Ag-0.5Cu, unless otherwise specified. This material has been verified to be compatible with PbSn assembly process.

2. Recommended Lead Free Solder Condition

- Recommended solder Sn-3.0Ag-0.5Cu.

Flow Solder Condition:

Pre-heating: maximum 120°C
within 90 sec.
Soldering: dip within 5 sec. at
255°C ± 5°C solder bath
Relay must be cooled by air immediately
after soldering

Solder by Soldering Iron:

Soldering Iron 30-60W
Temperature: maximum 350-360°C
Duration: maximum 3 sec.

We highly recommend that you confirm your actual solder conditions

3. Moisture Sensitivity

- Moisture Sensitivity Level standard is not applicable to electromechanical relays, unless otherwise indicated.

4. Tin Whiskers

- Dipped SnAgCu solder is known as presenting a low risk to tin whisker development. No considerable length whisker was found by our in house test.

Fujitsu Components International Headquarter Offices

Japan

Fujitsu Component Limited
Gotanda-Chuo Building
3-5, Higashigotanda 2-chome, Shinagawa-ku
Tokyo 141, Japan
Tel: (81-3) 5449-7010
Fax: (81-3) 5449-2626
Email: promothq@ft.ed.fujitsu.com
Web: www.fcl.fujitsu.com

North and South America

Fujitsu Components America, Inc.
250 E. Caribbean Drive
Sunnyvale, CA 94089 U.S.A.
Tel: (1-408) 745-4900
Fax: (1-408) 745-4970
Email: components@us.fujitsu.com
Web: <http://us.fujitsu.com/components>

Europe

Fujitsu Components Europe B.V.
Diamantlaan 25
2132 WV Hoofddorp
Netherlands
Tel: (31-23) 5560910
Fax: (31-23) 5560950
Email: info@fceu.fujitsu.com
Web: emea.fujitsu.com/components/

Asia Pacific

Fujitsu Components Asia Ltd.
102E Pasir Panjang Road
#01-01 Citilink Warehouse Complex
Singapore 118529
Tel: (65) 6375-8560
Fax: (65) 6273-3021
Email: fcal@fcal.fujitsu.com
Web: <http://www.fujitsu.com/sg/services/micro/components/>

©2014 Fujitsu Components Europe B.V. All rights reserved. All trademarks or registered trademarks are the property of their respective owners.

The contents, data and information in this datasheet are provided by Fujitsu Component Ltd. as a service only to its user and only for general information purposes.

The use of the contents, data and information provided in this datasheet is at the users' own risk.

Fujitsu has assembled this datasheet with care and will endeavor to keep the contents, data and information correct, accurate, comprehensive, complete and up to date.

Fujitsu Components Europe B.V. and affiliated companies do however not accept any responsibility or liability on their behalf, nor on behalf of its employees, for any loss or damage, direct, indirect or consequential, with respect to this datasheet, its contents, data, and information and related graphics and the correctness, reliability, accuracy, comprehensiveness, usefulness, availability and completeness thereof.

Nor do Fujitsu Components Europe B.V. and affiliated companies accept on their behalf, nor on behalf of its employees, any responsibility or liability for any representation or warrant of any kind, express or implied, including warranties of any kind for merchantability or fitness for particular use, with respect to these datasheets, its contents, data, information and related graphics and the correctness, reliability, accuracy, comprehensiveness, usefulness, availability and completeness thereof. Rev. May 21, 2014